

12 11 10 9 8 7 6 5 4 3 2 1

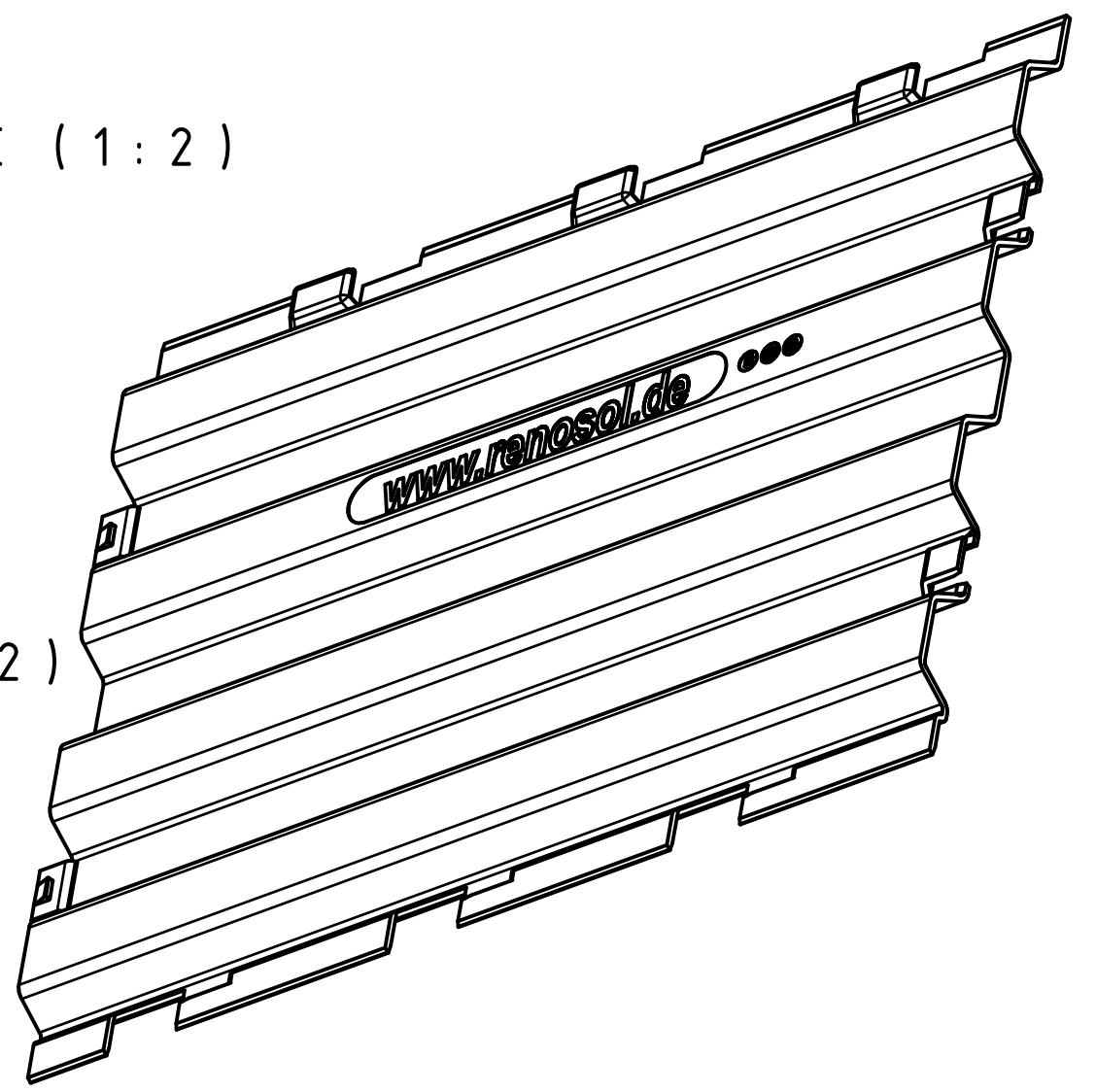

B-B (1 : 2)

A-A (1 : 2)

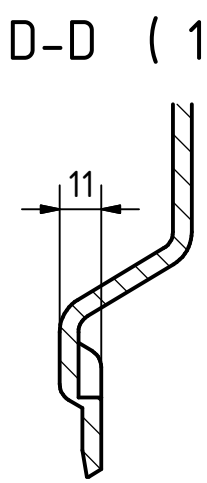
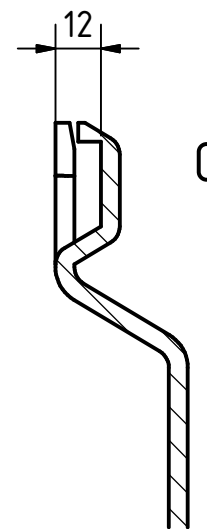
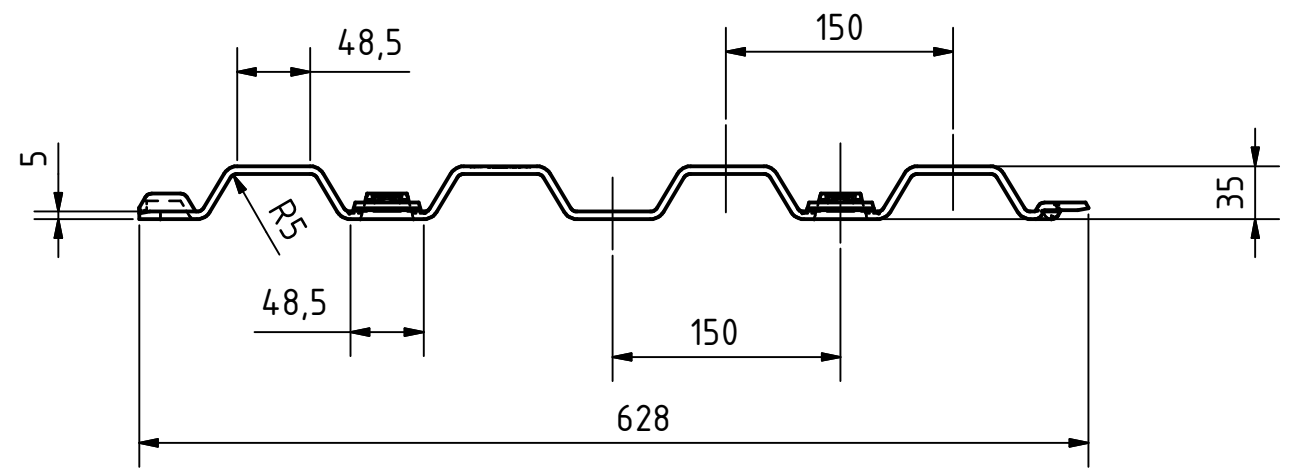
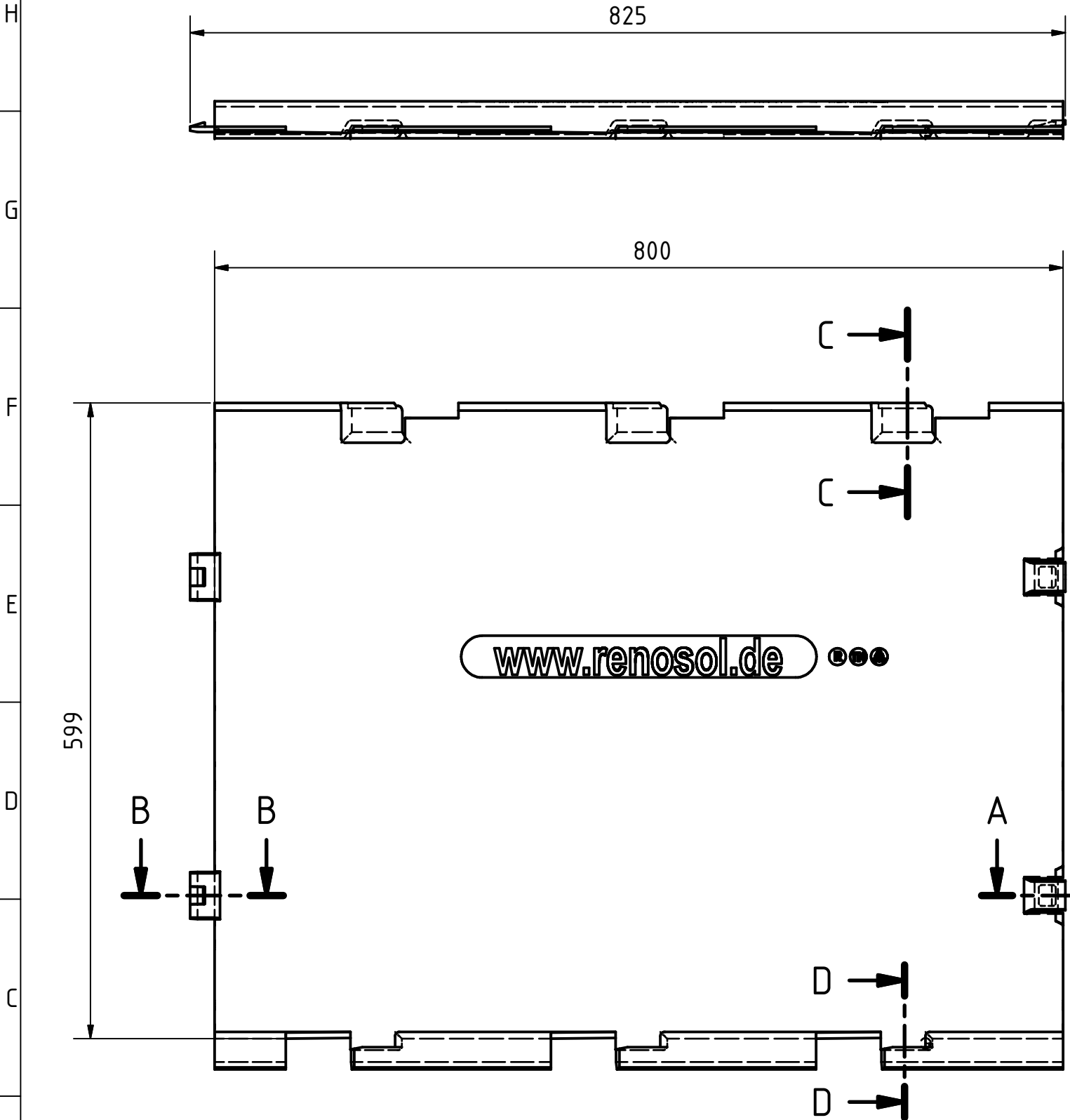
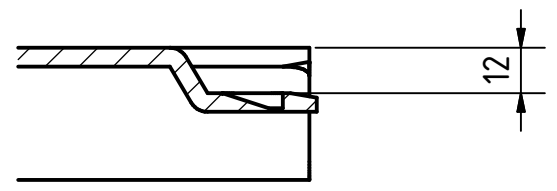
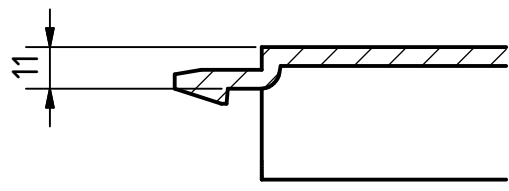

RENOSOL		Maßstab: 1:5 / 1:2	
		Werkstoff: HDPE	
	Datum	Name	
	Gezeichnet 17.07.2009	Becker	
	Kontrolliert		
	Norm		
		Trapezplatte 8478-800x600-090406	
		800x600-090406	
		1	
		A3	
Status	Änderungen	Datum	Name

12 11 10 9 8 7 6 5 4 3 2 1